

# Enclosed/Horse & Livestock

These front roof caps are available in four different widths and in both 6" and 12" radius models.

FRONT ROOF CAPS – FLAT						
Part #	Style	Gauge	Radius	Height	Width	Depth
6315	Flat	19	6"	8"	60"	8"
6316	Flat	19	6"	8"	72"	8"
6317	Flat	19	6"	8"	80"	8"
6318	Flat	19	6"	8"	84"	8"
6308	Flat	19	12"	13"	60"	13"
6306	Flat	19	12"	13"	72"	13"
6314	Flat	19	12"	13"	84"	13"
6313	Flat	19	12"	14"	80"	14"
6304	Low profile	19	6"	8"	60"	35"
6305	Low profile	19	6"	8"	72"	37"
6301	Round	19	12"	15"	60"	37"
6302	Round	19	12"	15"	72"	37"

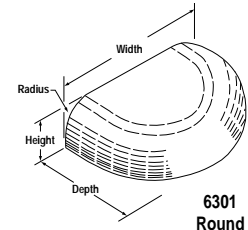
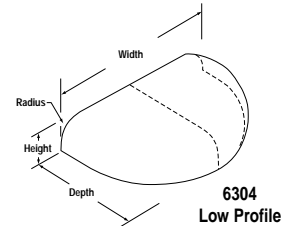
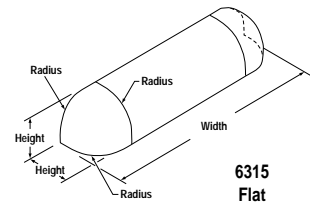

Ball corners are available in either steel or aluminum. The aluminum ball corners are fast becoming popular for both van and horse trailers.

BALL CORNERS		
Part #	Material	Description
6311	Steel	6" radius
6311-A	Aluminum	6" radius
6310	Steel	12" radius
6310-A	Aluminum	12" radius



All of our angled nose bows are available in several options and angles.

ROLLED NOSE BOWS				
Part #	Description	Width	Radius	Material
6420	Rolled nose angle	60"	30"	1.250" x 1.250", .125" steel
6421	Rolled nose angle	72"	36"	1.250" x 1.250", .125" steel
6424	Rolled nose angle	80"	40"	1.250" x 1.250", .125" steel
6422	Rolled nose bow	60"	30"	1" square 16 ga tubing
6423	Rolled nose bow	72"	36"	1" square 16 ga tubing

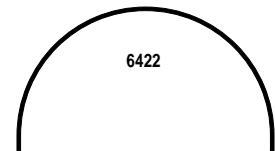

Gussets provide an integral part of the trailer's design, support and strength. They come in three sizes, with or without a lip. Rear gussets serve as a mounting place for tail lights. All gussets are heavy-duty metal.

GUSSETS		
Part #	Size	Description
10X46BGL	10" x 46" x .125"	1" lip, left hand
10X46BGR	10" x 46" x .125"	1" lip, right hand
6772-L	15" x 34" x .188"	1" lip, left hand
6772-R	15" x 34" x .188"	1" lip, right hand
7201	24" x 30" x .250"	No lip

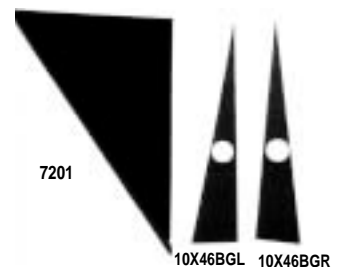

# Enclosed Horse & Livestock

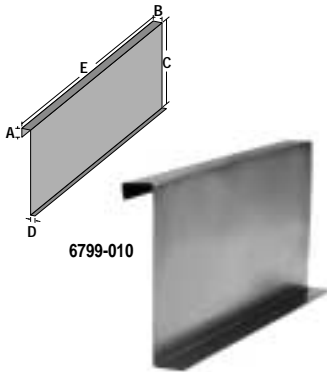

TRAILER SIDES						
Part #	Material	Dim. A	Dim. B	Dim. C	Dim. D	Dim. E
6753	16 ga cr	2"	2"	19"	1"	5'
6754	16 ga cr	2"	2"	19"	1"	8'
6755	16 ga cr	2"	2"	19"	1"	10'
6799-008	16 ga cr	2"	2"	24.125"	1"	5'
6799-009	16 ga cr	2"	2"	24.125"	1"	6'
6799-010	16 ga cr	2"	2"	24.125"	1"	10'

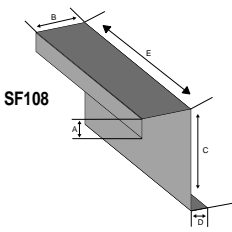

BRUSH FENDERS						
Part #	Material	Dim. A	Dim. B	Dim. C	Dim. D	Dim. E
SF108	11 gauge	2"	12"	20"	2"	8'
SF110	11 gauge	2"	12"	20"	2"	10'



BOTTOM PANELS			
Part #	Length	Width	Material
6801	10'	22.50"	16 gauge, cold roll
6830	10'	33"	16 gauge, cold roll
6832	10'	45"	16 gauge, cold roll
6802	12'	22.50"	16 gauge, cold roll



SIDE SLATS				
Part #	Description	Length	Width	Material
6701	Flat	10'	5"	16 gauge, cold roll
6702	Flat	12'	5"	16 gauge, cold roll
6704	Grooved	16'	6"	18 gauge, cold roll
6703	Grooved	20'	6"	18 gauge, cold roll
6705	Grooved	24'	6"	18 gauge, cold roll

Our feed and saddle doors come complete with hinge installed.

FEED & SADDLE DOORS				
Part #	Description	Width	Height	Gauge
6375	Rolled saddle door	30"	33"	16
6376	Rolled saddle door	30"	36"	16
6381	Flat saddle door	30"	33"	16
6370	Feed door	17"	23"	16

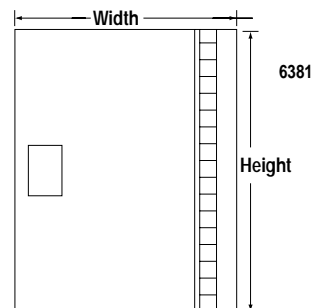
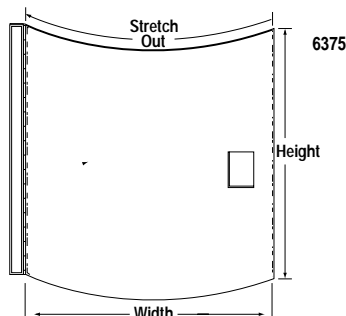

# Enclosed Horse & Livestock

All roof bows are 16 gauge and 1" square tubing which produces a true radius.

ROOF BOWS				
Part # (Straight)	Part # (Cambered)	Height	Width	Radius
6412-7	6412-C7	7"	60"	6"
6413-7	6413-C7	7"	72"	6"
6408-7	6408-C7	7"	80"	6"
6409-7	6409-C7	7"	84"	6"
6415-7	6415-C7	7"	96"	6"
6412	6412-C	8"	60"	6"
6413	6413-C	8"	72"	6"
6408	6408-C	8"	80"	6"
6409	6409-C	8"	84"	6"
6415	6415-C	8"	96"	6"
6411-13	6411-C13	13"	72"	12"
6410	6410-C	14"	60"	12"
6411	6411-C	14"	72"	12"
6407	6407-C	14"	80"	12"
6416	6416-C	14"	84"	12"
6414	6414-C	14"	96"	12"

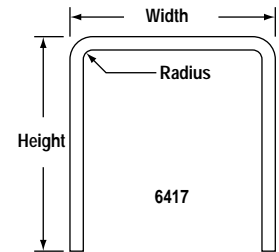
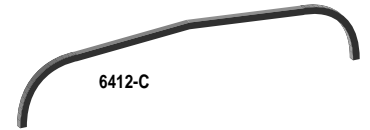

PIPE BOWS			
Part #	Height	Width	Radius
6417	78"	72"	6"



Heavy duty steps by Hickory Step ensure a safe means to step up into your trailer.

FOLDING STEP	
Part #	Description
HS1001	24" Single fold out step
HS1002	24" Double fold out step

Our quality constructed camper doors have the following special features:

- Weathertight seal, quiet operation,
- Secure locking flush-mount latch,
- Left-hand opening – hinges on the right,
- Fiberglass construction,
- Inner foam core,
- 12" x 27" vertical sliding window.

CAMPER DOORS	
Part #	Description
CD2460	24" x 60" Cut-out size
CD2464	24" x 64" Cut-out size
CD2468	24" x 68" Cut-out size
CD2868	28" x 68" Cut-out size
CD3060	30" x 60" Cut-out size
CD3066	30" x 66" Cut-out size
CD3068	30" x 68" Cut-out size
CD3660	36" x 60" Cut-out size
CD3664	36" x 64" Cut-out size
CD3668	36" x 68" Cut-out size
CDLAT	Replacement latch assembly with key for camper doors



# Enclosed Horse & Livestock

These Creation windows are 90° radius with a tempered safety glass. All windows have black frames with inside screens and are available in a mill aluminum finish (change the “B” in the part numbers to “M”). These windows are designed to fit either left or right-hand side and have weep hole drainage plugs on top and bottom. It comes with an inside lock and outside handles. Multiple clamp ring thicknesses are available upon request.

C2414B

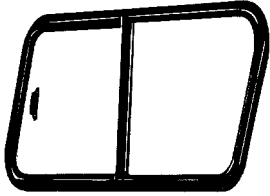

C4414B



CREATION 90° RADIUS WINDOWS			
Window Part #	Size	Clamp Ring Part #	Wall Thickness
C1614B	16" x 14"	CR1614B5	.125" or .75 Reversed
C17751075B	17.75" x 10.75"	CR17751075B10	1.3125"
C1815B	18" x 15"	CR1815B7	1.0625"
C2114B	21" x 14"	CR2114B9	1.250"
C2414B	24" x 14"	CR2414B9	1.28125"
C2415B	24" x 15"	CR2415B14	2.125"
C3414B	34" x 14"	CR3414B7	1.0625"
C3415B	34" x 15"	CR3415B14	2.125"
C4414B	44" x 14"	CR4414B5	.125" or .75 Reversed
C4815B	48" x 15"	CR4815B9	1.250"
C5313B	53" x 13"	CR5313B18	.0625" Skin mount
C5319B	53" x 19"	CR5319B14	2.125"

Edge trim is flexible plastic molding used to cover sharp edges. It is easy to cut and install, and fits up to 1/8" diameter.

CET50



EDGE TRIM	
Part #	Description
CET50	Chrome edge trim, 50' roll
CET50-BK	Black edge trim, 50' roll

49PL-12

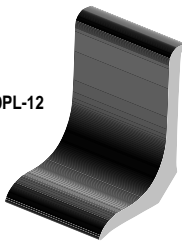

Dress up your horse/livestock trailer with “V” type trim.

“V” TYPE TRIM	
Part #	Description
49PL-12	“V” type trim, 12' x 1.125"

1924-12

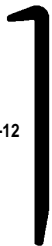

Lipped trim is used around doors and windows. It can also be used to cover the seam between two sheets of metal.

LIPPED TRIM		
Part #	Description	Size
1923-12	Chrome lipped trim	1" x 12'
1923-21	Chrome lipped trim	1" x 21'
1924-12	Chrome lipped trim	1.250" x 12'
1924-21	Chrome lipped trim	1.250" x 21'
2625-12	Chrome lipped trim	1.625" x 12'
2625-21	Chrome lipped trim	1.625" x 21'

# Enclosed Horse & Livestock

## SELF-ADHESIVE TRIM

Part #	Description	Size
SAT137CBK	Self-adhesive trim with black insert	1.385" wide, 100' roll
SAT137CRD	Self-adhesive trim with red insert	1.385" wide, 100' roll
SAT137WE	Self-adhesive trim with white insert	1.385" wide, 100' roll
SAT137CSL	Self-adhesive trim with silver insert	1.385" wide, 100' roll

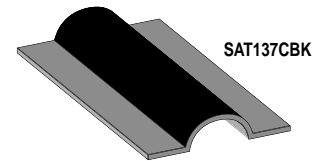

The trim end cap is an aluminum cap that protects the trim and insert.

## TRIM END CAP

Part #	Description
RV908-ECM	End cap with mill finish
RV908-ECCW	End cap with white finish
RV908-ECBLK	End cap with black finish

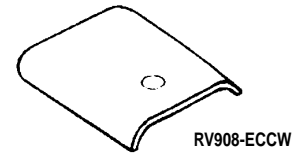

Flat trim is used on seams around your trailer body. It covers any unattractive sealants around the joints of adjacent panels.

## FLAT TRIM

Part #	Description	Size
6439-34	Flat chrome trim	12' x .750"
6439-138	Flat chrome trim	12' x 1.385"



Drip rail trim is used at the seam of your trailer's roof and sides. It prevents water from running down the sides of your trailer.

## DRIP RAIL TRIM

Part #	Description	Size
688-12	Chrome drip rail trim	12' x .750"



Insert trim is used to cover joints and seams. It is available in 12' or 21' lengths. Colored vinyl insert is also available.

## INSERT TRIM

Part #	Description	Size
2605-12	Chrome lip insert, even	12' x 1.250"
2605-21	Chrome lip insert, even	21' x 1.188"
1904-21	Chrome lip insert, uneven	21' x 1.188"

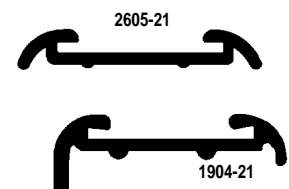

Vinyl insert is sold by the roll (750') or by the foot. It is used with 1904 or 2605 insert trim and has a 1" width.

## VINYL INSERT

Part # the foot	Part # by the roll	Description
VI-BLACK	VI-BLACK-750	Vinyl insert, black
VI-RED	VI-RED-750	Vinyl insert, red
VI-WHITE	VI-WHITE-750	Vinyl insert, white
VI-BLUE	VI-BLUE-750	Vinyl insert, blue
VI-SILVER	VI-SILVER-750	Vinyl insert, silver
VI-BROWN	VI-BROWN-750	Vinyl insert, brown
VI-TEAL	VI-TEAL-750	Vinyl insert, teal



# Enclosed Horse & Livestock

**DUO-THERM**

AC-13500



Keep your cool with an air conditioner from Duo Therm. Mounts in standard vent cutout.

## DUO THERM AIR CONDITIONERS

Part #	Description
AC-13500	Rooftop AC unit, 110V, 13,500 BTU with 3 speed fan
AC-VENT	Interior airbox with vents and controls
AC-HS	Heat strip, 5,600 BTU for AC-13500

AC-HS



Crank-out dome vents come complete with a screen and inside trim. All vents are complete with inner trim garnish. This ventilator can be used as a vent or skylight.

## DOMED VENTILATORS

Part #	Size	Description
6504	14" x 14"	With white acrylic top, metal flange and garnish
6505	14" x 14"	With white acrylic top, metal flange, garnish and 12 volt fan
6506	14" x 14"	With smoke acrylic top, metal flange and garnish
6507	22" x 22"	With white acrylic top, metal flange and garnish

6504

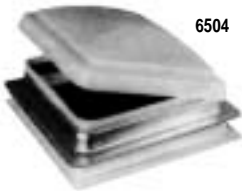

Providing a large opening for increased air flow, this roof pop-up ventilator comes complete with screen, gasket, and a lever operated pop-up vent. Interior garnish is available.

## ROOF POP-UP VENTILATORS

Part #	Size	Description
9106	8" x 12"	Salem 2-way pop-up vent with screen
9106AL	8" x 12"	Salem 2-way pop-up vent with screen, aluminum

9106



6502

The complete unit includes a gasket, an interior butterfly vent, and a roof-mount sloped roof vent.

## SLOPED ROOF VENTILATORS

Part #	Size	Description
6502	10" x 12"	Sloped roof vent, complete



6501

Butterfly vents are a polished aluminum vent that is both attractive and a functional source of ventilation. Ideal for use on horse, stock, dog, or cargo van trailers.

## BUTTERFLY VENT

Part #	Size	Description
6501	7.50"	Polished aluminum vent



AGG6



Our aluminum gravel guard is made of a high quality brushed aluminum and has an attractive diamond design. Sold by the foot or 250' rolls.

## GRAVEL GUARD - ALUMINUM

Part # by the foot	Part # by the roll	Description	Width
AGG6	AGG6-250	Gravel guard, aluminum	6"
AGG7	AGG7-250	Gravel guard, aluminum	7"
AGG9	AGG9-250	Gravel guard, aluminum	9"
AGG12	AGG12-250	Gravel guard, aluminum	12"
AGG14	AGG14-250	Gravel guard, aluminum	14"
AGG18	AGG18-250	Gravel guard, aluminum	18"

# Enclosed Horse & Livestock

Deluxe, black vinyl gravel guard has an adhesive back and provides a non-skid step-type surface as an alternative to aluminum gravel guard. It is sold by the foot or by the roll.

GRAVEL GUARD - VINYL			
Part # by the foot	Part # by the roll	Description	Width
VGG1.5	VGG1.5-300	Gravel guard, vinyl	1.50"
VGG5	VGG5-300	Gravel guard, vinyl	5"
VGG7	VGG7-300	Gravel guard, vinyl	7"
VGG9	VGG9-300	Gravel guard, vinyl	9"
VGG12	VGG12-300	Gravel guard, vinyl	12"

VGG9



MUD FLAPS			
Part #	Width	Length	Thickness
6255	19"	24"	.385"
6258	24"	30"	.385"

6255



Available by the foot or in 40' rolls.

RUBBER MATTING			
Part # by the foot	Part # by the roll	Size	Description
6250	6250-40	28" x .313"	Horse trailer rubber matting
6251	6251-40	30" x .313"	Horse trailer rubber matting
6252	6252-40	34" x .313"	Horse trailer rubber matting
6253	6253-40	36" x .313"	Horse trailer rubber matting

6250



This heavy-duty stall mat for horse trailers is thicker than regular trailer mat. It comes in a variety of thicknesses and surfaces.

STALL MATS		
Part #	Description	Size
48X72DP12	Stall mat, diamond pattern	48" x 72" x .50"
48X84DP12	Stall mat, diamond pattern	48" x 84" x .50"
48X72GM12	Stall mat, grooved	48" x 72" x .50"
48X81GM12	Stall mat, grooved	48" x 81" x .50"
48X72SM12	Stall mat, smooth	48" x 72" x .50"
48X72SM34	Stall mat, smooth	48" x 72" x .750"
48X84SM12	Stall mat, smooth	48" x 84" x .50"
60X72SM34	Stall mat, smooth	60" x 72" x .750"
60X84SM12	Stall mat, smooth	60" x 84" x .50"
60X84SM34	Stall mat, smooth	60" x 84" x .750"

48X72GM



Available by the foot or in 40' rolls.

WALL LINER			
Part # by the foot	Part # by the roll	Description	Size
5870	5870-40	Wall liner	34" x .250"
5871	5871-40	Wall liner	36" x .250"

5870



# Enclosed Horse & Livestock

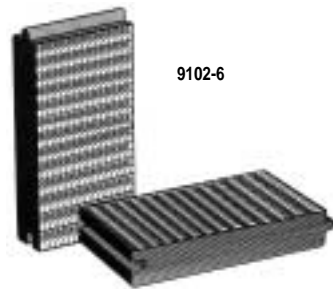
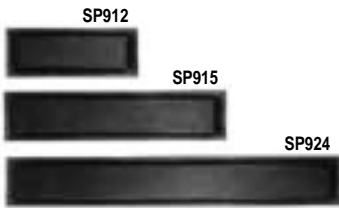

HORSE TRAILER PADS		
Part #	Description	Size
SP912	Side pad	9" x 12"
SP915	Side pad	9" x 15"
SP924	Side pad	9" x 24"
SP938	Side pad	9" x 38"
SP940	Side pad	9" x 40"
SP960	Side pad	9" x 60"
BP2424	Breast pad	24" x 24"

This trailer flooring is made of recycled tires and other materials for added strength. It is both a flooring and rubber mat. It has a 1 1/2" groove.

DELUXE TRAILER FLOORING		
Part #	Description	Size
9102-6	Trailer flooring	6' tongue & groove, 8" x 2"
9102-7	Trailer flooring	7' tongue & groove, 8" x 2"
9102-16	Trailer flooring	16' tongue & groove, 8" x 2"
9102-20	Trailer flooring	20' tongue & groove, 8" x 2"
9102-24	Trailer flooring	24' tongue & groove, 8" x 2"

DECALS	
Part #	Description
LB1	Wiring decal
LB2	Warning to check lug nuts and tire pressure
LB3	Caution! Do not exceed manufacturer's vehicle weight ratings or loading recommendations
LB4	Check before towing
LB5	Trailer is not to be towed unless brakes are working and safety chains are securely . . .
LB6	Caution! Secure all gate latches before moving trailer
LB7	Safety breakaway systems will not operate unless connected to a power source . . .

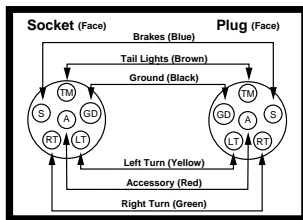

LB1

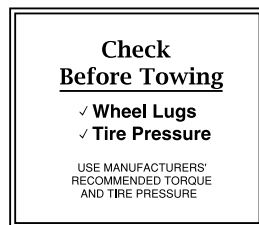

LB2



LB3



LB4



LB5



LB6

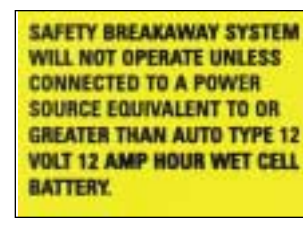

LB7